

CCQ-800
AUTO FOCIMETER
User Manual



Version: V2.04

Revision date: 2025.06

Product Name: AUTO FOCIMETER
Nome do produto: AUTO FOC ÍMETRO
Nombre del producto: FOC ÍMETRO AUTOMÁTICO
Ürün Adı: OTOMATİK ODAK METRE
Nome prodotto: AUTOFOCIMETRO
Produktname: Automatischer Fokusmesser
Nom du produit: FOCIMÈTRE AUTOMATIQUE
Име на продукта: АВТОМАТИЧЕН ФОКИМЕТЪР
Produkto pavadinimas: Automatinis dioptrimetras
Nazwa produktu: AUTOFOCYMETR
N ázev produktu: AUTOMATICKÝ FOCIMETR
Toote nimi: AUTOMAATNE FOOKUSMÕÕTUR
Produkta nosaukums: AUTOMĀTISKAIS FOCIMETRS
Όνομα προϊόντος: ΑΥΤΟΜΑΤΟ ΕΣΤΙΟΜΕΤΡΟ
Numele produsului: FOCIMETRU AUTOMAT
Productnaam: AUTOMATISCHE FOTOMETER

User Manual Download link: www.yeasn.com/en/
Link para download do manual do usu ário: www.yeasn.com/en/
Manual de usuario Enlace de descarga: www.yeasn.com/en/
Kullanım Kılavuzu İndirme linki: www.yeasn.com/en/
Manuale d'uso Link per il download: www.yeasn.com/en/
Link zum Herunterladen des Benutzerhandbuchs: www.yeasn.com/en/
Lien de t échargement du manuel d'utilisation : www.yeasn.com/en/
Линк за изтегляне на ръководството за потребителя: www.yeasn.com/en/
Naudotojo vadovo atsisiuntimo nuoroda: www.yeasn.com/en/
Link do pobrania instrukcji obsługi: www.yeasn.com/en/
Uživatelská příručka Odkaz ke stažení: www.yeasn.com/en/
Kasutusjuhendi allalaadimise link: www.yeasn.com/en/
Lietotāja rokasgrāmatas lejupielādes saite: www.yeasn.com/en/
Εγχειρίδιο χρήστη Σύνδεσμος λήψης: www.yeasn.com/en/
Link de descărcare manual de utilizare: www.yeasn.com/en/
Gebruikershandleiding Downloadlink: www.yeasn.com/en/

Preface

Thanks for purchasing and using CCQ-800 auto focimeter (Focimeter, also the widely called Lensmeter, is officially named in EN ISO 8598: Optics and Optical instruments–Focimeter).



Please read this User Manual carefully before using this device. We sincerely hope that this User Manual will provide you with sufficient information to use the device.

Our pursuit is to provide people with high-quality, complete-function and more personalized devices. Information in promotional materials and packing boxes is subject to changes due to performance improvement without additional notice. Chongqing Yeasn Science - Technology Co., Ltd. reserves the rights to update the devices and materials.

If you have any questions during using, please contact at our service hotline: (86-023) 62797666, we will be very happy to help you.

Your satisfaction, our impetus!

Information of manufacturer

Name: CHONGQING YEASN SCIENCE - TECHNOLOGY CO., LTD.

Address: 5 DANLONG ROAD, NANAN DISTRICT, CHONGQING, CHINA

Tel: 86-23 62797666

Authorized representative

Shanghai International Holding Corp.GmbH(Europe)

Eiffestrasse 80, 20537 Hamburg, Germany

MEDRIGHT TECH INC

13525 40TH RD STE 3FFLUSHING, NY 11354

KINGSMEAD SERVICE LIMITED

19 Mezzanine Floor 19-21 CrawfordStreet

London W1H 1PJ England,United Kingdom

Content

1. Introduction	1
1.1 Uses	1
1.2 Characteristics	1
1.3 Main technical indexes	1
1.4 Name plate and indications	2
2. Safety Notice	4
2.1 Before use	4
2.2 Using	5
2.3 After use	6
3. Main structure	7
3.1 Front view	7
3.2 Side view and Back view	7
4. Interface	8
4.1 Measurement interface	8
4.2 Other measurement interface	10
4.3 Parameter Setting Interface	12
5. Installations and Calibration	13
6. Operating procedures	13
6.1 Measurement Preparation	13
6.2 Setting Lenses	14
6.3 Measuring Single Vision Lens	15
6.4 Measuring Multifocal Lens	15
6.5 Measuring Progressive Power Lens	17
6.6 Measuring Contact Lens	19
6.7 PD and PH measuring	20
6.8 Measuring UV Transmittance	21
6.9 Marking	22
6.10 Quickly measure PD	22
6.11 Mark prism prescription	24
6.12 Lens Distortion Detection	26
6.13 Printout	27
6.14 After use	28
6.15 Parameter Setting	29

6.16 Parameter table	29
7. Trouble-shooting	36
7.1 Troubleshooting method.....	36
7.2 Error messages and countermeasures.....	36
8. Cleaning and protection	37
8.1 Cleaning the protective glass.....	37
8.2 Cleaning the lens	37
8.3 Others	37
9. Maintenance	37
9.1 Replacing printer paper	37
9.2 Refilling ink.....	38
10. Environmental Conditions and Service Life	39
10.1 Environmental conditions for normal operation	39
10.2 Environmental conditions for transportation and storage	39
10.3 Service life.....	39
11. Environmental protection	39
12. Manufacturer's Responsibility	40
13. Electrical Schematic Diagram	41
14. Guidance of EMC and other interference	41

1. Introduction

1.1 Uses

CCQ-800 auto focimeter mainly measures spherical power, cylindrical power and axis of the cylindrical lens as well as contact lens. It marks on the uncut lens and checks if the spectacle lens is correctly mounted.

Target groups of patients: The product is measured for ophthalmic lenses and is not intended for patients.

Intended users: optometrists in hospital ophthalmology and optical shops.

Specific qualifications of device users and/or other persons: have a qualification certificate for optometry and glasses.

Contraindications: none.

1.2 Characteristics

- 7-inch TFT color touch screen;
- Green LED light, ABBE compensation;
- Hartmann sensor;
- High-speed parallel processing system;
- Low transmittance lens measurement;
- Low astigmatism lens measurement;
- 20Δ Prism measurement;
- Lens type auto identification;
- PD, PH and UV measurement;
- Built-in thermal printer.

1.3 Main technical indexes









1.3.1 Spherical power (spectacle lens):	-25D~ +25D
1.3.2 Cylindrical power:	-9.99D~ +9.99D
1.3.3 ADD power:	0~ +9.99D
1.3.4 Spherical power (contact lens):	-20D~ +20D
1.3.5 Dioptor step:	0.01D, 0.06D, 0.12D, 0.25D
1.3.6 Axis:	0 °~180 °; Increment: 1 °
1.3.7 Prism basal angle:	0 °~360 °; Increment: 1 °

1.3.8 Prism power:	horizontal: 0~20△; Increment: 0.01△ vertical: 0~20△; Increment: 0.01△
1.3.9 Applicable lenses:	φ20mm~φ100mm
1.3.10 Applicable center thickness:	≥20mm
1.3.11 PD measurement:	40mm ~ 82mm; Increment: 0.20mm
1.3.12 ΔPH measurement:	0mm ~ 28.3mm; Increment: 0.20mm
1.3.13 Measurement of UVA transmittance:	Center400nm
1.3.14 Instrument body power:	Input: DC 12V, 40W
1.3.15 AC Adapter:	Input: AC 100V ~ 240V, 50Hz ~ 60Hz Output: DC 12V, 40W
1.3.16 Size:	235(W) ×246(D) ×487(H) mm
1.3.17 Weight:	5.45 kg
1.3.18 Display:	TFT touch screen, 800×480 pixs
1.3.19 Printer:	Thermal printer, 57 mm width
1.3.20 Interface connectors:	USB, RS-232

1.4 Name plate and indications

Name plate and indications are pasted on the instrument to arise end-users' notice.

In case the name plate is not pasted well or the characters become unclear to recognize, please contact authorized distributors.

	Power switch identification
	Refer to instruction manual / booklet
	Manufacturer
	Manufacturing date
	Serial number
	Country of manufacture
	CE marking
	Correct Disposal of This Product (Waste Electrical & Electronic Equipment)
	Medical device



Consult instructions for use



Authorized European representative



Authorized UK representative



Authorized America representative



Catalogue number



Unique Device Identifier



Model number

G.W.

Gross Weight

DIM.

Dimension



This way up



Fragile, handle with care



Keep dry



Do not roll



Stacking limit by 5



Recyclable



Temperature limit



Humidity limitation



Atmospheric pressure limitation

We will make available on request circuit diagrams, component part lists, descriptions, calibration instructions, or other information that will assist service personnel to repair those parts of ME equipment that are designated by the manufacturer as repairable by service personnel.

2. Safety Notice



Please read the following precautions carefully to avoid personal injury, device damages or other possible hazards:

2.1 Before use

- No technical demands for operator, and read manual before using.
- Do not posit the equipment to make it difficult to operate the power plug which uses to isolate the equipment circuits electrically form the supply mains.
- Do not use the device for other than the intended purpose.

YEASN will not be responsible for accidents or malfunction caused by such carelessness.

- Never modify or touch the internal structure of the device.

This may result in electric shock or malfunction.

Do not store the device in an area that is exposed to rain or water, or contains poisonous gas or liquid.

Corrosion or malfunction of the device may occur.

- Avoid installing the device where it is exposed to direct air-conditioning flow.

Changes in temperature may result in condensation inside the device or adversely affect measurements.

- Avoid using the device in a place exposed to direct sunlight or near incandescent light.

Under such circumstances, the device may work irregularly or issue error messages.

- Be sure to use a wall outlet which meets the power specification requirements.

If the line voltage is too high or too low, the device may not give full performance. Malfunction or fire may occur.

- The electrical outlet must have a grounding terminal.

Electric shock or fire may occur in the event of malfunction or power leakage.

- Insert the main plug into an outlet as far as the prongs of the plug will go.

Fire may occur if the device is used with a loose connection.

- For supplying the device with the power, never use a table tap or extension cable.

The electrical safety may be lowered.

- Do not place heavy objects on the power cord.

The damaged power cord may cause fire or electric shock.

- Before connecting a cable, turn off the power switch and disconnect the power cord from outlet.

Malfunction of the device may occur.

- To transport the device, use the special packing materials to protect the device from impact of dropping.

Excessive vibration or impact to the device may cause malfunction.

- In installation and operation of the device, observe the following instructions about EMC (electromagnetic compatibility):

—Do not use the device simultaneously with other electronic equipment to avoid electromagnetic interference with the operation of the device.

—Do not use the device near, on, or under other electronic equipment to avoid electromagnetic interference with the operation of the device.

—Do not use the device in the same room with other equipment such as life-support equipment, other equipment that has major affects on the life of the patient and results of treatment, or other measurement or treatment equipment that involves small electric current.

—Do not use the device simultaneously with portable and mobile radio frequency communication systems because it may have an adverse effect on operation of the device.

—Do not use cables and accessories that are not specified for the device because that may increase the emission of electromagnetic waves from the device or the system and decrease the immunity of the device to electromagnetic disturbance.

- The Electromagnetic Compatibility Directive sets the essential requirements for electrical and electronic equipment that may disturb, or be disturbed by, other equipment. The CCQ-800 complies with these requirements. Follow the guidance in the tables for use of the device in an electromagnetic environment.

- Ground wire should be installed indoor and the instrument should be grounded well.

- The instrument should not be installed in place where disconnection is not possible.

2.2 Using

- Immediately replace the power cord if the internal wires are exposed, turns on or off the table when the power cord is moved, or the cord and/or plug are too hot to be held with hands.

This may result in electric shock or fire.

In the event of malfunction, disconnect the power cord from the wall outlet. Never touch the

inside of the device, then contact your authorized distributor.

These limits are designed to provide reasonable protection against harmful interference in a standard medical installation .

This device generates uses and can radiate radio frequency energy and, if not installed and used in accordance with the instructions, may cause harmful interference to other devices in the vicinity.

However, there is no guarantee that interference will not occur in a particular installation. If this device does cause harmful interference to other devices, which can be determined by turning the device off and on, the user is encouraged to try to correct the interference by one or more of the following measures:

Reorient or relocate the receiving device.

Increase the separation between the devices.

Connect the device to an outlet on a circuit different from that to which the other device(s) are connected.

Consult the manufacturer or field service technician for help.

- Never use the device with cables or accessories other than the designated ones.

Malfunction caused by deteriorated electromagnetic compatibility (EMC) characteristics may occur.

- Never use portable and mobile radio frequency (RF) devices in the vicinity of this device.

These devices may adversely affect medical electrical equipment and malfunction may occur.

- When moving the device, do not place your hands on the frame of the display but hold the underside and sides with both hands.

Injury or malfunction may occur.

2.3 After use

- When the device is not in use, turn it off and cover the dustproof cover. Otherwise dust will affect the measurement accuracy.

- Clean the prongs of the main plug with a dry cloth often. If dust settles between the prongs, the dust will collect moisture, and short circuit or fire may occur.

- If the device will not be used for a long time, disconnect the power cord from the wall outlet, as fire may occur.

- Notification: Any serious event related to the device to the user and/or patient shall be reported to the manufacturer and competent authority of the Member State where the user and/or patient is located.

- Caution: The user is cautioned that changes or modifications not expressly approved by the party responsible for compliance could void the user's authority to operate the equipment.

3. Main structure

3.1 Front view

- 1. Front upper cover
- 2. Marking unit
- 3. Lens pressing unit
- 4. Lens support
- 5. Power switch
- 6. Front lower cover
- 7. Read key
- 8. Lens pushing board
- 9. Lens pushing board lever
- 10. Screen
- 11. Pilot lamp

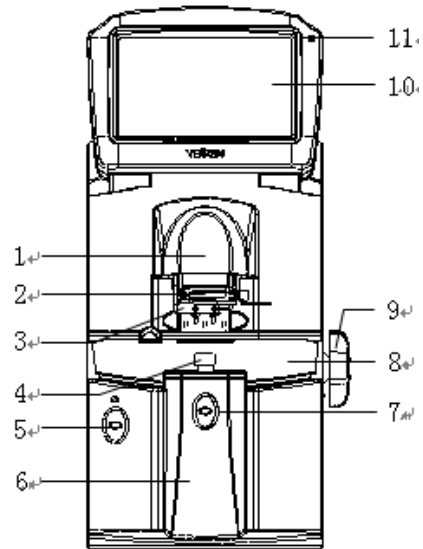

3.2 Side view and Back view

- 12. Print cover
- 13. Power supply inlet
- 14. RS-232 connector
- 15. USB connector

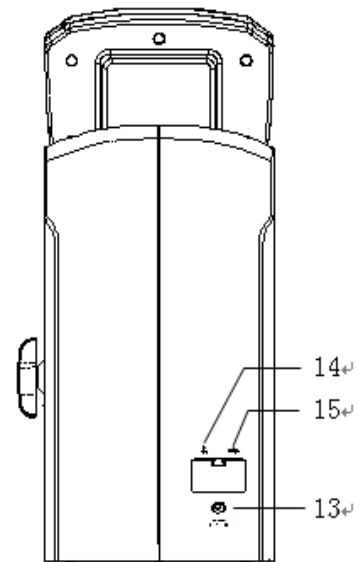
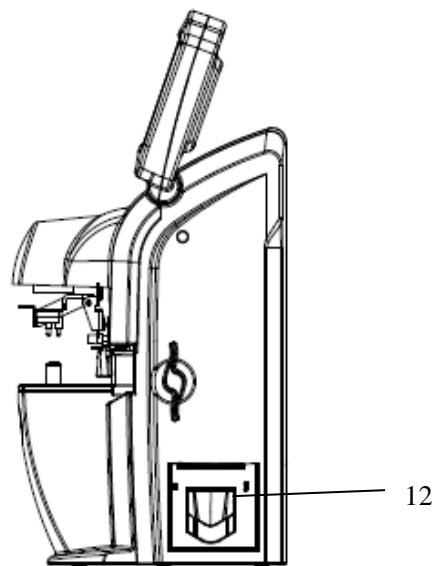

4. Interface

4.1 Measurement interface

Measurement interface includes: Normal Measurement Interface, Progressive Power Lens (PPL) Measurement Interface, Contact Lens Measurement Interface, PD and PH Measurement Interface, and UV Transmittance Measurement Interface.

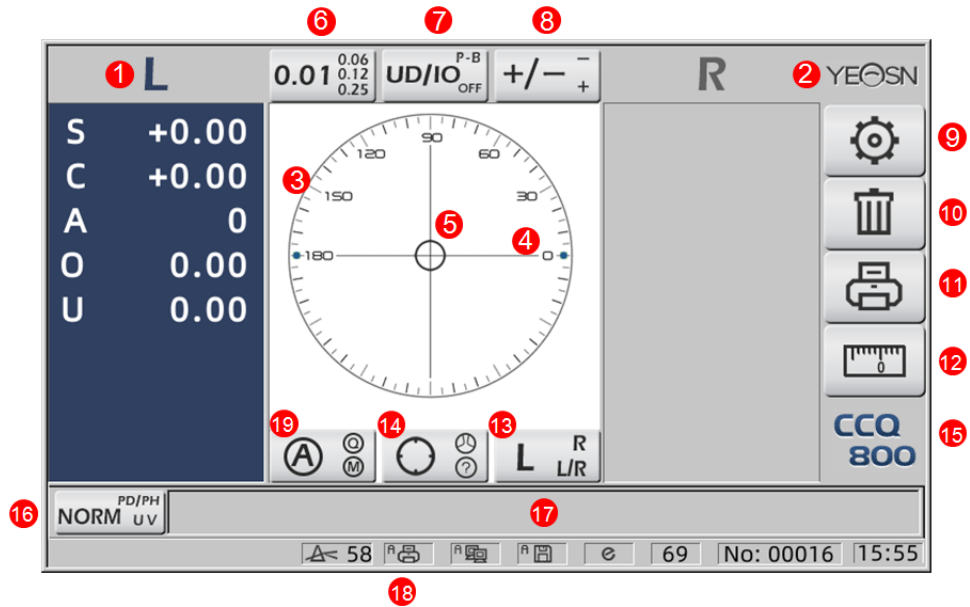

1. L/R indication

It shows all left or right lens measurement states. Data below shows measured data of corresponding lens measuring state, L/R inductions are shown as below:

L	Left lens is not measured
L	Left lens measurement is finished, and measured data is saved
R	Right lens is not measured
R	Right lens measurement is finished, and measured data is saved

2. Yeasn Logo

3. Alignment circle

The center of alignment circle shows the optical center, axis bar and target are shown in the alignment circle.



4. Axis bar

It's shown in the alignment circle, and corresponding position indicates axis of measured lens.

5. Target

The position of target in alignment circle indicates direction and distance of measured lens to optical center. When target moves closer to optical center, the shape changes in the shown way:



	Far from optical center
	Near optical center. Measured data can be directly read by pressing Read key
	In optical center. Measured data automatically gets fixed in auto read mode, and measured data gets fixed by pressing Read key in manual read mode.

6. Step indication shortcut tab

It shows measurement step, including: 0.01D, 0.06D, 0.12D, 0.25D.

Settings of all parameters in measurement screen can be referred to 6.15.1 Measurement screen shortcut setting.

7. Prism indication shortcut tab

The prism result can be indicated in three modes: UD/IO, P-B, OFF. (See details in 6.16 Parameter Table)

8. Astigmatism indication shortcut tab

Cylinder is indicated in three modes: +, +/- and - (See details in 6.16 Parameter Table)

9. Set:

Press the icon, then it comes to parameter setting interface.

10. Clear:

It clears the memorized data, and release fixed data, then measured result comes to zero.

11. Print:

Do printing according to parameter setting mode in "Print", or "Economic print".

12. Quick PD measurement:

13. L/R lens selection shortcut tab:

Choose left or right lens for measurement, including "L/R", "L" and "R". (See details in 6.16 Parameter Table)



14. Measurement mode shortcut tab

Measurement mode includes "Auto Identification Measurement Mode", "Normal Measurement Mode" and "Progressive Power Lens Measurement Mode". (See details in 6.16 Parameter Table)

15. Model number

16. Measurement function switch shortcut tab

It realizes fast switch among the three functions below:

	Normal measurement
	PD and PH measurement
	UV transmittance measurement

17. Measurement process indication area

It shows hint messages and parameters of PD, PH and UV transmittance.

18. Status bar area

It includes the hint messages of "ABBE", "Output mode" and "Datum wavelength". (See details in 6.16 Parameter Table). The diameter of measured lens displays from 20-100, unit: mm; time and date shows YYYY - MM - DD and HH: MM.

19. Shift key of reading mode

Choose reading mode including Auto Read, Manual Read and Quick read (see details in 6.16 Parameter Table).

4.2 Other measurement interface

4.2.1 Progressive Power Lens Measurement Interface

1. Progressive power lens measurement alignment circle

There are two alignment circles, respectively in far portion and near portion.

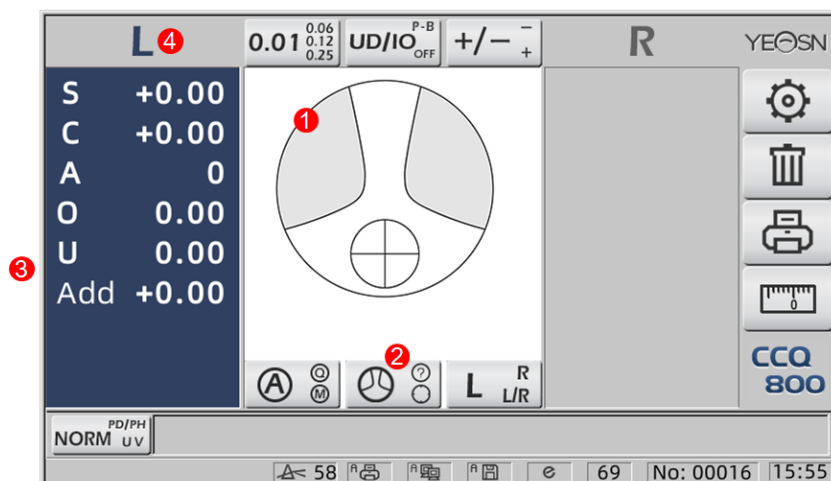

2. Measurement mode switch icon:



3. near portion measurement

Measurement data has an additional item - "Add".

4. If measure mode is L/R. When measured right lens, and will wait to measure left lens, will not change.

4.2.2 Contact Lens Measurement Interface

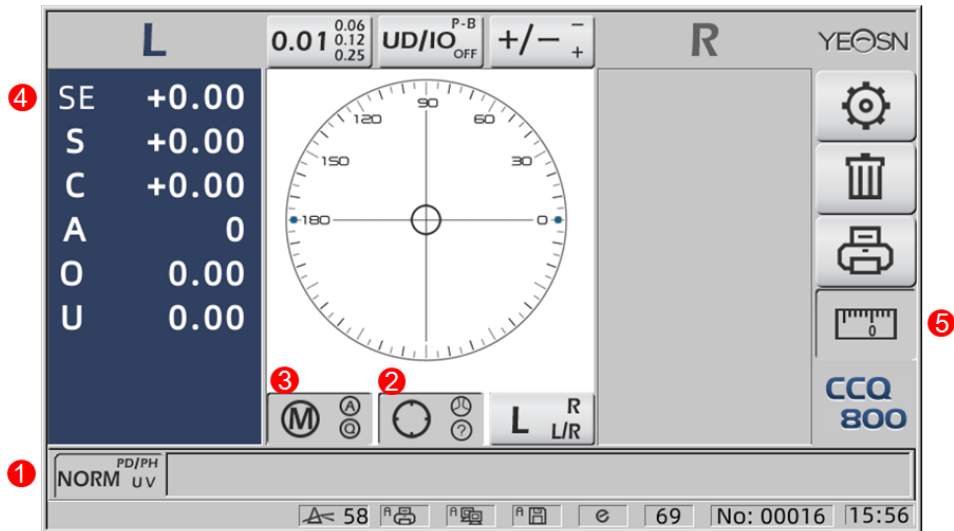

1. Measurement function switch is invalid.

2. Measurement mode switch is invalid.

3. Reading mode switch is invalid.

4. Contact lens measurement value SE.

5. Quick PD measurement is invalid.

4.2.3 "PD/PH" Pupil Distance & Height Measurement Interface

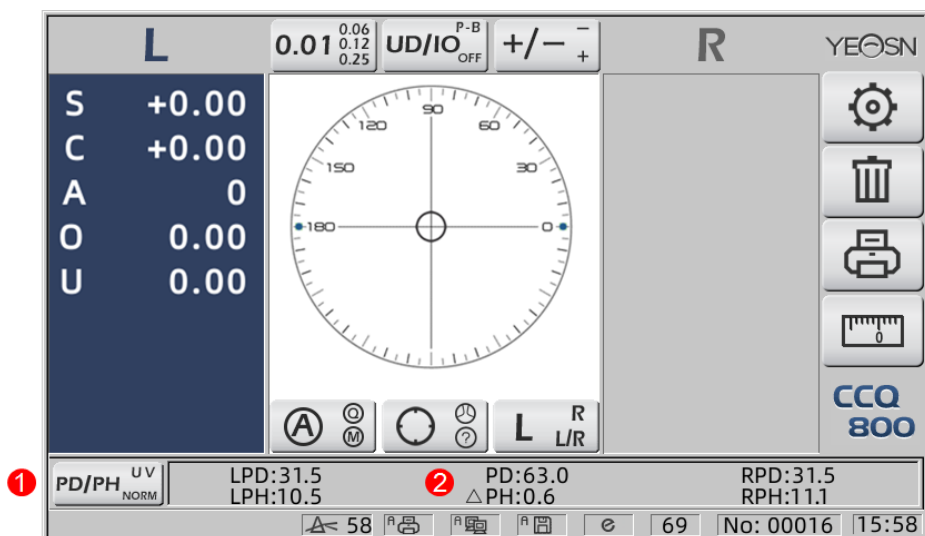

1. Measurement function switch icon:



2. Status bar shows LPD, PD, RPD, LPF, ΔPH, RPH.

4.2.4 UV Transmittance Measurement Interface

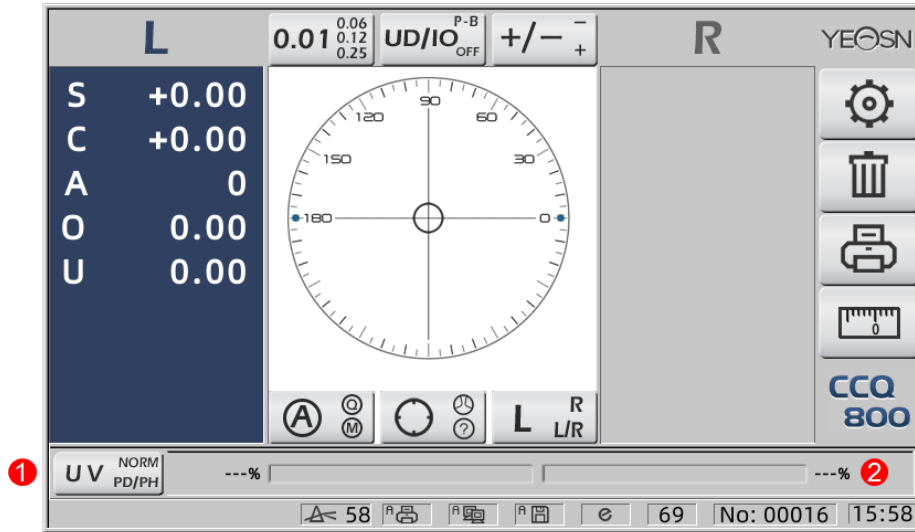

1. UV transmittance measurement shortcut tab:



2. UV transmittance measurement result

4.3 Parameter Setting Interface

It displays parameters related to the instrument. "Lens", "Display", "System", "Communication" and "information" pages are correspondent to parameters of the five different types, and the five icons can also be used to switch among the five pages. Press the tab and release it, then it switches to the page.

In each page, parameter items are shown in the left side, and corresponding parameters are listed on the right. Press "OK" to save data, or press "Cancel" to cancel change.

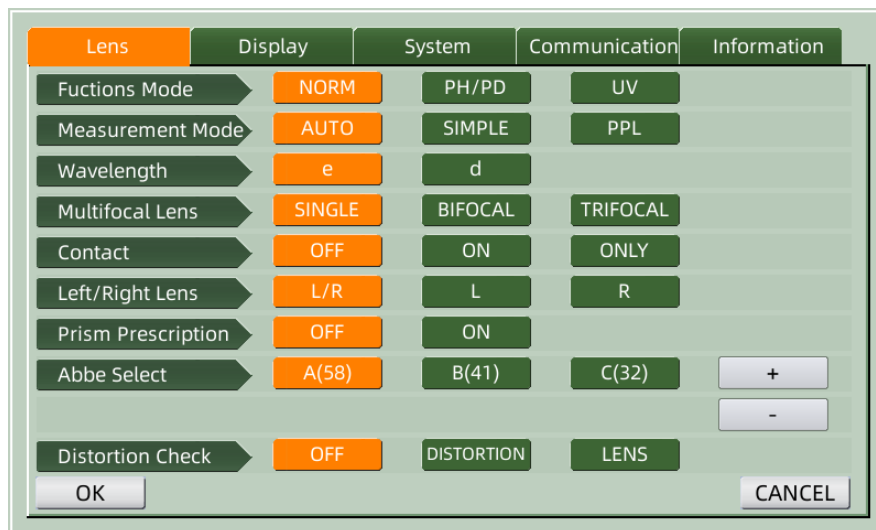

5. Installations and Calibration

Place the instrument on fixed table, and connect power. Detailed steps are shown below:

- a. Place the instrument on stable and fixed table.
- b. Lightly put down the instrument upright.
- c. Connect the plug of power adapter to the socket.
- d. Put the DC power output of power adapter into the instrument.
- e. Switch on the instrument. The screen becomes working, and then instrument gets started
- f. The instrument comes to measurement mode interface.
- g. If the brightness are not comfortable, then adjust them (see details in 6.15 Parameter setting).

6. Operating procedures

6.1 Measurement Preparation

6.1.1 Connect the Power Supply

Connect the adapter to an electrical socket, and then to the instrument.

6.1.2 Turn the power on

Wait for the progress bar load finish, and then the instrument automatically enters into measurement interface.

6.1.3 After starting-up, the screen enters into measurement interface.

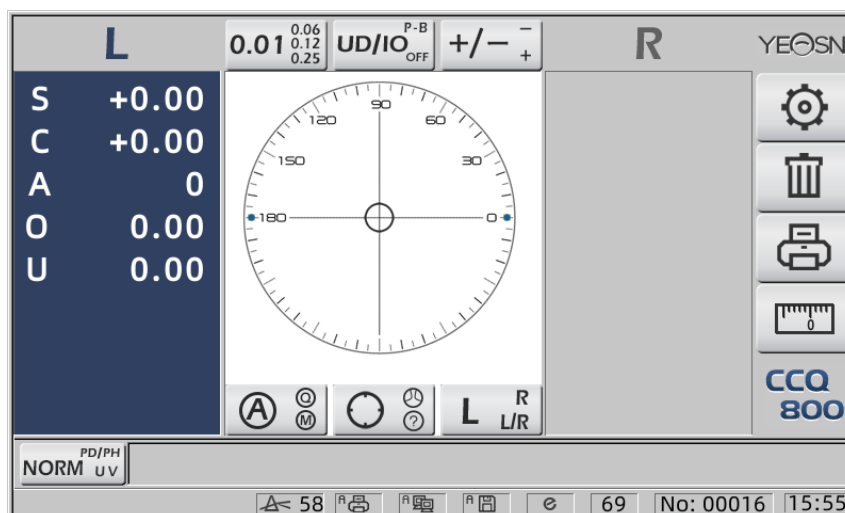

- The power-on measurement interface is related to measurement mode, “Contact Lens” parameter and lens support type used. If “Contact Lens” parameter is set to “ONLY”, and spectacle lens support is used, the message “Do you want to use contact lens support?” appears on start-up interface, and then you can choose parameters according to needs.

Spectacle lens measurement	Change the lens support to spectacle one, then restart the instrument; the screen will display according to the "Measurement Mode" parameters.
Contact lens measurement	Change the lens support to contact one, then restart the instrument, the interface changes to contact lens measurement interface, in such a case, then interface will not change to any other measurement interface.

- Other messages and solutions please see "7.2" as a reference.

6.2 Setting Lenses

6.2.1 Set uncut lens

a. Set lens on Lens support

Place the lens center on the Lens support with the convex side up.

b. Fix the lens to Lens support

Raise the lens pressing unit, and then lower it slowly to fix the lens.

- Lens pushing board is not needed to fix uncut lens.



Fig.6.2.1 a



Fig.6.2.1 b

6.2.2 Set framed lens



Fig.6.2.2 a



Fig.6.2.2 b

a. Set framed lens

Place the framed lens on Lens support with front surface upward.

b. Move lens pushing board

Turn the lens pushing board lever until it touches and parallel the bottom of the frames.

c. Fix lens with lens pressing unit

Raise the lens pressing unit, and then lower it slowly to fix the lens.

6.3 Measuring Single Vision Lens

Single vision lenses are measured on the Auto Identification Measurement Mode or Normal Measurement Mode, the procedure is as follows:

a. Specify lens side if necessary

Specify lens side by pressing R/L shortcut tab. If it's automatic R/L switch mode, the instrument automatically identifies the first measured lens as the right lens. After the measured data is fixed, it goes automatically to left lens measurement.

- If lens side is only specified after measurement, the measured data will be cleared.

b. Perform lens alignment

Move the lens to bring target close to the center of alignment circle. If it's framed lenses, move the lens pushing board along the frames. When alignment is finished, make sure that the bottom of the frames is touched with lens pushing board.

c. Fix measured data

When alignment is finished, the measured data is fixed by pressing Read key in manual read mode or automatically fixed under auto read mode.

- Cylinder indication shortcut tab still works in terms of changing the indication mode of cylinder value even after measured data is fixed.

d. Measuring other lenses

If it is necessary to measure the other lenses, then follow the same step as above.

e. Print measured data

When the measurement is completed, press "Print" to print out the measured data.

If needs be, the measured data can be sent to other instruments, computer, for example, by setting parameter in "Data Output" and connecting to other instruments.

6.4 Measuring Multifocal Lens

Bifocal measure step: distance portion---near portion (as to trifocal lenses, the order is distance portion --- middle portion --- near portion)

- Measure lens under auto and normal model.

- a. make sure the left and right of lens.
- b. measure the degree of distance portion.

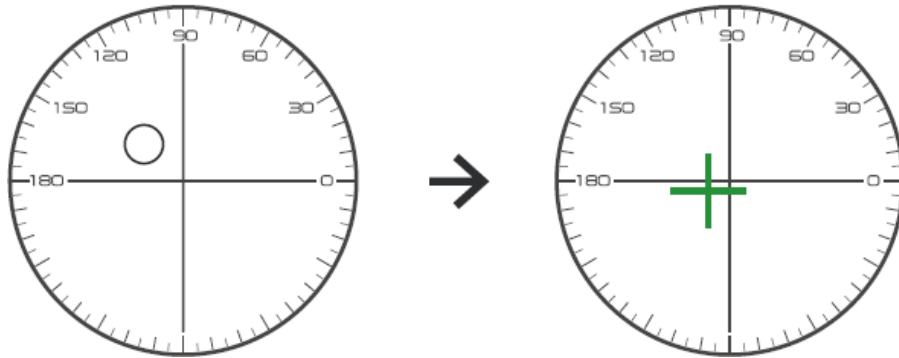

First moving the distance portion of lens to the bracket ,and then focus, when the target change from circle mark to cross mark , press the reading button , distance portion measurement complete.

- c. measuring the near portion add power.(Add: the first add power)

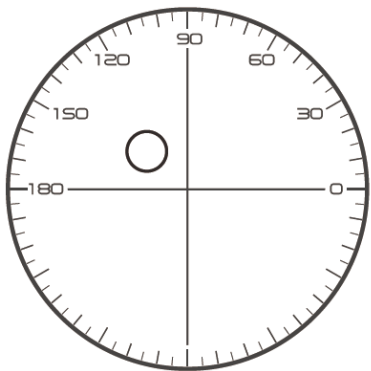

- Not necessary to alignment the target mark
- The “auto reading ” is forbidden
- taking down the lens during the measuring process, please remeasure from distance portion

Moving the lens to measurement direction to make the near portion located on the bracket (as to trifocal lens, moving the middle portion to the bracket), and press the reading button, the degree of near portion measurement complete.

As to bifocal, the measure step finished.

As to trifocal, please process step d to measure add power of near portion.

- d. measuring the near portion add power. (Ad2: the second add power)

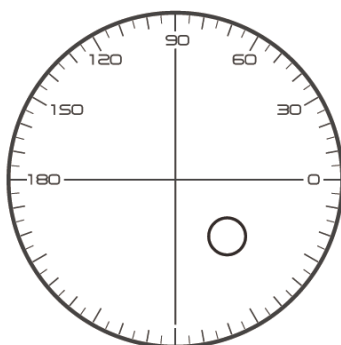

- Not necessary to alignment the target mark
- The “auto reading” is forbidden
- Taking down the lens during the measuring process, please remeasure from distance portion

Moving the near portion to bracket, and press the reading button, the second add power (Ad2) of near portion measurement complete.

As to trifocal, the measure step finished.

6.5 Measuring Progressive Power Lens

6.5.1 Measure uncut lens

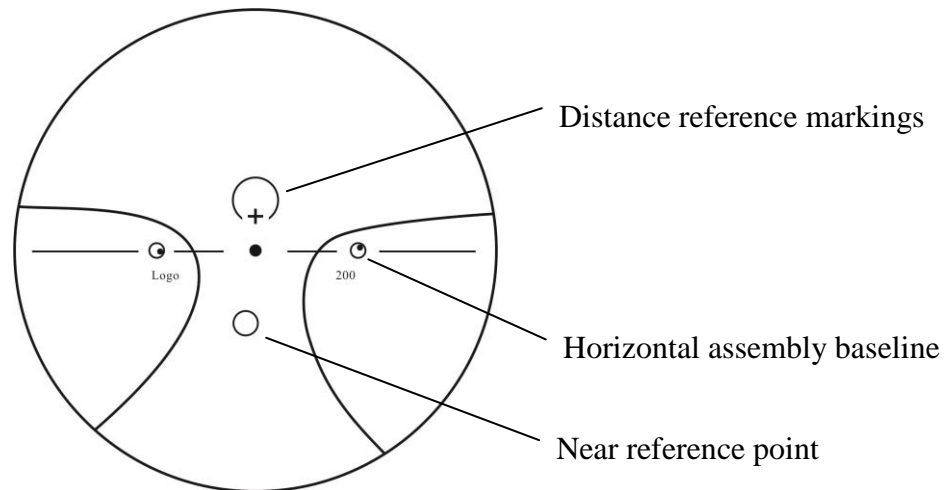

Measure the vertex power of the lens at the mark of the far and the near printed on the uncut lens, and measure it manually.

Place the progressive surface of the lens on the measuring holder, place the lens so the near reference point of the lens is centered on the measuring holder, and press the reading key to measure the near vertex power.

Keep the progressive surface of the lens facing the measuring holder, center the distance reference point of the lens on the measuring holder, and press the reading key to measure the distance vertex power.

The difference between the near vertex power and the far vertex power is the near additional vertex power of the progressive lens.

- When placing the lens, its horizontal assembly baseline must be parallel to the Lens pushing board, and try to align the center of the lens marking ring with the center of the light hole of the measuring holder to make the measurement accurate.

6.5.2 Measuring framed lens

Measure a lens on PPL measurement mode or auto identification measurement mode.

Under auto identification measurement mode, when the lens on the lens support is detected as a progressive power lens, the interface changes to the PPL measurement interface automatically, the procedure is as follows:

- a. Change to the PPL measurement interface
- b. Specify lens side if necessary
- c. Set lens

Place a portion that is slightly lower than the center of the lens on the lens support.

- d. Measure distance power

1) When measuring distance portion, the target indicating the distance portion is displayed, and the message bar displays "Now measuring distance.... "

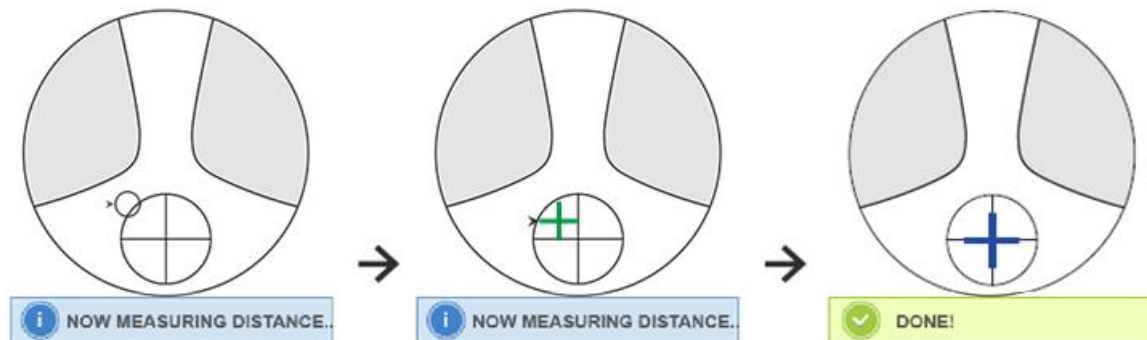

- 2) Perform the alignment

Move the lens in the horizontal direction to align the target with vertical line of the cross, and then move the lens in vertical direction to align the target with horizontal line of the cross until the target becomes blue, the procedure is as follows:

- Arrow indicates the direction should be moved toward, move the lens slowly during alignment in the direction of arrow.
- The lens should be always contacted with support, when move the lens, keep the frame adjoin to push board.

3) Move the lens in vertical and horizontal direction slightly until the measured data stabilizes, and then the message "Near Measurement Complete" appears.

- e. Measure near ADD power

1) When the distance power measurement is complete, the target indicating the near portion appears, the message bar displays "Now measuring near... ". At the same time the ADD power begins to change.

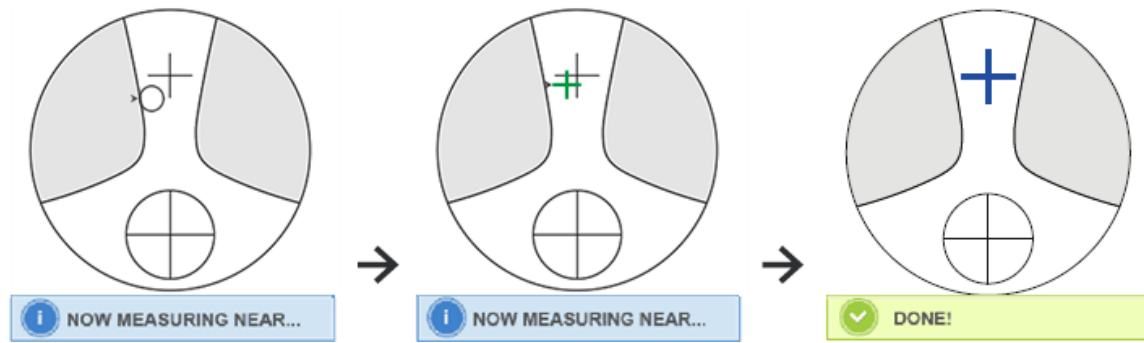

2) Perform alignment

Move the lens horizontally to align the target with vertical line of the cross, and then move the lens vertically to align the target with horizontal line of the cross until the target becomes blue, the procedure is as follows:

- Arrow indicates the direction should be moved toward, move the lens slowly during alignment in the direction of arrow.
- The lens should be always contacted with support, when move the lens, keep the frame adjoin to push board.

3) Move the lens in vertical and horizontal direction slightly until the measured date stabilizes, then the message "Near Measurement Complete" appears.

f. Measure the other lens

g. Print out measured data

- After the ADD power is measured, the automatic L/R selection function begins to work.
- This function is only for demonstration and comparison. The Measurement results are for reference only. results are for reference only.

6.6 Measuring Contact Lens

Detailed steps of contact lens measurement are shown as below under Contact Lens Measurement Mode:

a. Change the spectacle lens support into contact lens support especially for contact lens

b. Contact Lens Measurement Mode switch

Come to Parameter Setting interface, and set parameter of "Contact Lens" to "ON" or "ONLY", then save the result to finish Contact Lens Measurement Mode switch process (see details in 6.16).

c. Set contact lens

Set the lens onto Lens support with convex side up. If it's soft contact lens, remove moisture from the surface with soft cloth before putting it onto Lens support.

- Hold a contact lens with tweezers. Be careful not to press the lens with lens pressing unit.

d. Align the contact lens, pushing its end lightly with tweezers tips.

e. Get measured result by pressing Read key after alignment

- Auto Read mode is not working for contact lens measurement, which can only be achieved by pressing Read key.

- Among measured data, a SE value will be displayed, which is 1/2 of the cylinder value added to the sphere value. When a non-cylindrical contact lens is measured and still a cylinder value is detected, the SE value will be more reliable than the SPH value to know the total sphere value. It reduces the error in the measured data made by the unintended cylinder value.

f. Measure other lens if necessary.

g. Print out measured result.

- Measure a soft contact lens as quickly as possible before the lens surface becomes dry. Because the lens contains water and is made of soft material, the lens cannot stay spherical for a long time, altering the measured data.

6.7 PD and PH measuring

In Auto measurement mode, detailed steps of PD and PH of framed lens are shown as below:

a. Press Measurement function switch shortcut tab to choose PD and PH measurement function.

b. Set the framed lens

1) Place the framed lens center on the lens support. Raise the lens pressing unit, and then lower it slowly to fix the lens.

2) Turn the lens pushing board lever. Press down nose pad slider of instrument to make sure it fixed on the two nose pad of the lens frame. The lens pushing board lever touches and parallel the bottom of the frames.



3) Right lens measurement

Move the right lens. When the alignment and the measurement data is finished, the PD/PH of the right lens is measured.

4) Left lens measurement

Move the left lens. When the alignment and the measurement data is finished, the PD/PH of the right lens is measured.

Or you can go from left to right lens as your needs.

- To make the measurement more accurate, move the left and right lens towards the same direction when proceed the alignment.
- Make sure the nose pad slider is fixed when measuring the lens.
- To make accurate measurement of the low astigmatism lens, use “manual reading”. Make the Prism power IO,UD as small as possible.

c. Measurement result display

After PD and PH of both lenses are confirmed, the result is get and displayed.

d. Print out measured result.

- This function is only for demonstration and comparison. The Measurement results are for reference only.

6.8 Measuring UV Transmittance

In Normal Measurement Mode, detailed steps of UV transmittance measurement are shown as below:

- a. Press Measurement function switch shortcut tab to choose UV transmittance measurement function.
- b. Set the lens onto Lens support
- c. Alignment
 - When measuring UV transmittance, the result may be not accurate if alignment is not done

well.

d. UV Transmittance measurement

After alignment, press Read key to finish measurement once, and you get measured result, the UV Transmittance, in the form of percentage.

- Harmful effects of UV (ultraviolet rays) on the eyes.

This feature is for demonstration purposes only and the measurement results are for reference only.

The UV contained in sunlight is roughly classified into three types.

UV-C 280nm or less	It will not reach the earth's surface.
UV-B 280 nm to 320nm	It Was absorbed by the cornea. Causing corneal loss, such as inflammation. Cause sunburn. The skin turns red. Causes skin irritation and skin damage, such as: blemishes, freckles and wrinkles.
UV-A 320nm to 380nm	Gathered in the lens, may cause cataracts. Cause sunburn. The skin darkens.

CCQ-800 can measure UVA transmittance.

Because UV-A is the most harmful UV light, measuring UV-A transmittance can be an effective assessment of protection.

- This function is only for demonstration and comparison. The Measurement results are for reference only.

6.9 Marking



Detailed steps of optical center and axis of measured lens marking are shown as below:

- Set the lens onto Lens support.
 - Align the lens and then do the marking.
 - After alignment is finished, fix the lens with lens pressing unit.
 - Mark the lens with marker.
 - Remove the lens by uplifting lens pressing unit.
- Do not touch the marked dots, or the unclear dots will make the axis not able to read.

6.10 Quickly measure PD

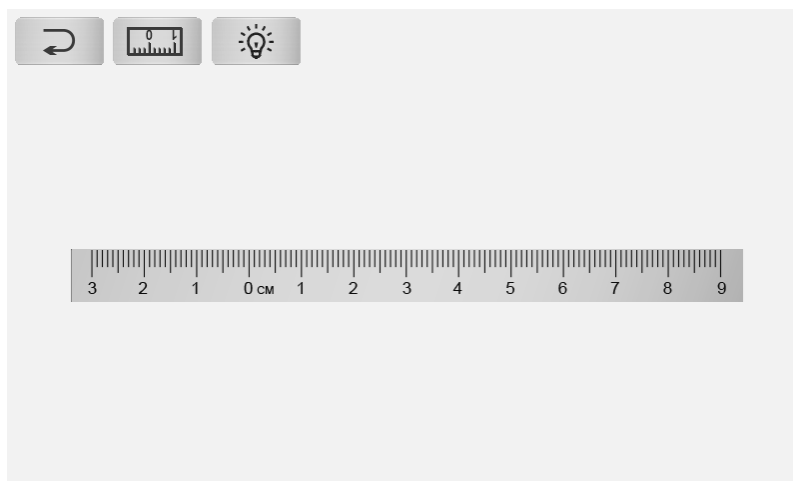
6.10.1 Press  to enter the measuring mode of PD quick measurement.





	Back
	Shift to accurate measuring mode
	Shift light of background

Put mark dot to ruler and fast to read PD.

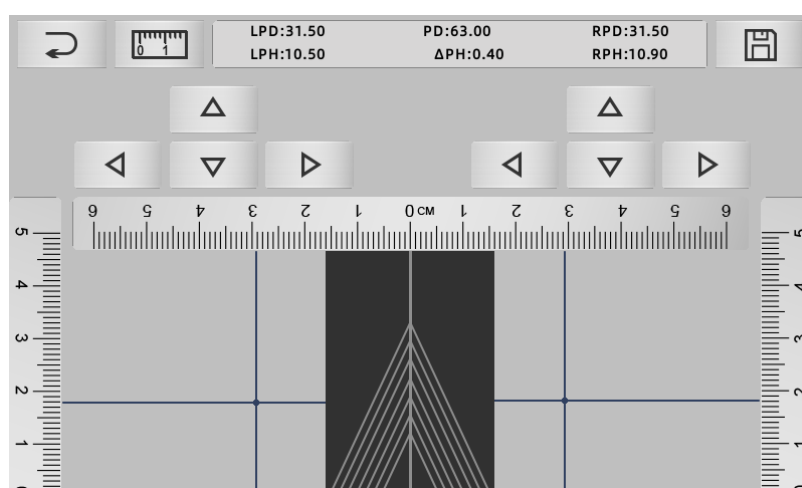
6.10.2 Press  to enter the measuring mode of accurate measurement.



	back
	Shift to fast measuring mode
	Keep the result and exit

- Click blank area of central line, and put green "+" target
- Put frame glasses to screen, lower frame approach to bottom of screen, nose pad part put on diagonal line and make frame glasses be in center position.



c. Use direction key to adjust position of "+" target, and make it double with mark dot of left and right lens.

d. Press save key, and will show PD, PH data, and locked.

- The data of PD, PH locked, PD slider will enter to locking condition, must press  to clear data.
- After using direction key to move, target area will be locked, cannot repeat procedure a.
- This function is only for demonstration and comparison. The Measurement results are for reference only.

6.11 Mark prism prescription

This function is used to mark the prescription lenses for implicit strabismus.

Pre-input prism prescription will make the target reverse the distance of the value of the prism data, to the positive lens, to align the target with the center of the focus ring, and to mark the lens.

In the lens parameter setting page (6.16.1), the prism prescription item is set to be enabled. At this time, the prism value in the measurement interface is highlighted and becomes operable.

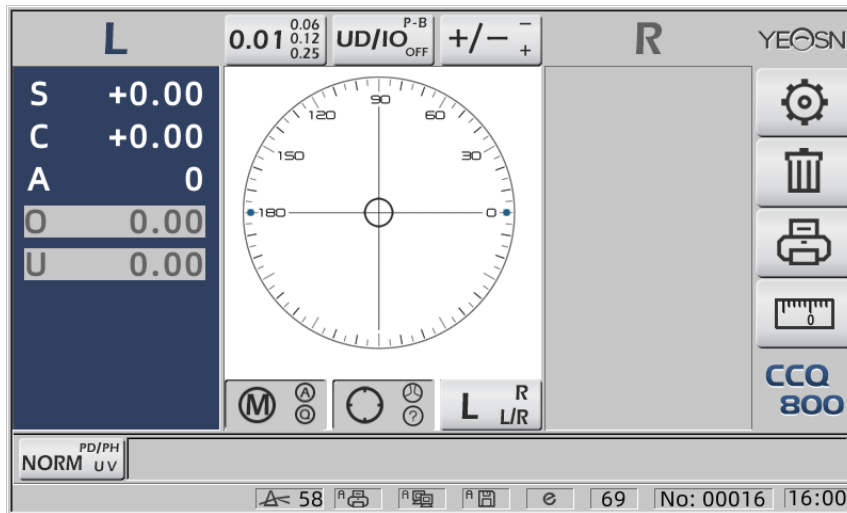

Touch the prism value and input the prism prescription through the keyboard.

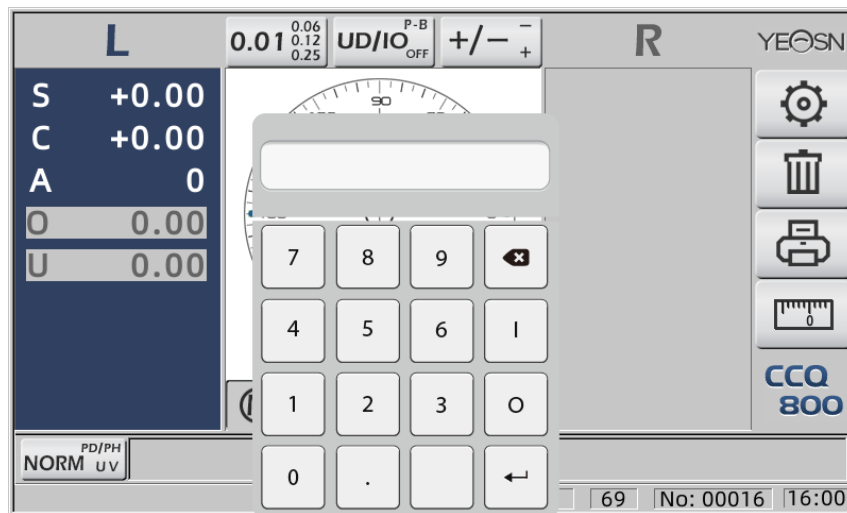

After prism prescription is input, the target moves the distance of prism data in reverse direction.

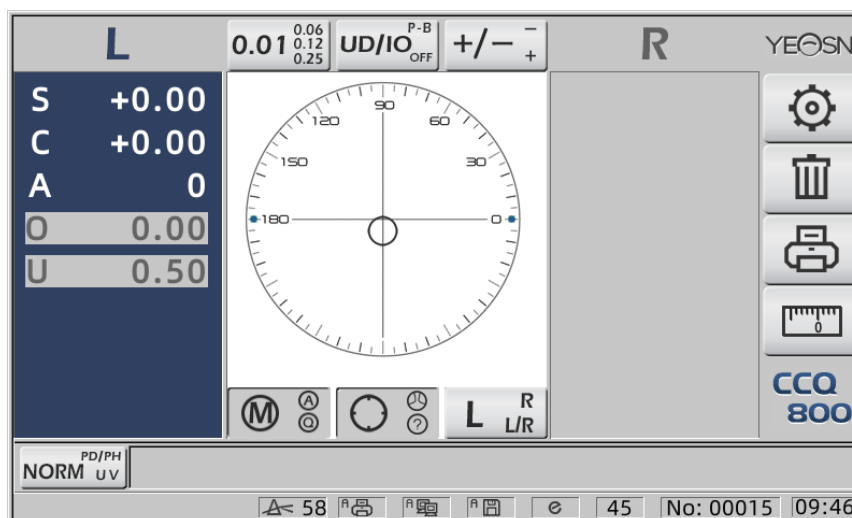

- According to the expression of prisms, prism prescription can be input in Cartesian coordinate system and polar coordinate system.
- The maximum 20 delta prism prescription can be put into the polar coordinates. When the

prism prescription is shown in a Cartesian coordinate, a value less than 20 delta may not be allowed to input, so that limit the absolute prism value expressed in polar coordinates to 20 Delta.

6.12 Lens Distortion Detection

6.12.1 Check the distortion difference between the eight distribution points on the lens and the vertex difference at the center of the lens

a. This function is to measure customer lens by obtaining light aperture of measurement supporter to eight parts around the lens aperture vertex power and the results compared with ISO standard tolerance

● This function is only for demonstration and comparison. The Measurement results are for reference only. The distortion of the whole lens cannot be measured. Besides, due to design of lens, e.g. Aspherical lens, may be detected as distortion

Parameters setting include three options: “Close”, “Distortion Found”, and “Lens Found”

Can choose on setting page (6.16.1).

b. Target lens and Measurement method

Target lens: Single vision Lens

Measurement mode: Normal single vision lens or automatic measurement, not include ADD.

Automatic measurement mode, when lens put on measurement supporter, detected lens, distortion function will be in activation condition.

When detected as progressive lens, interface will automatically shift to progressive lens measurement condition. And then, distortion detection function will shift to non-activation condition.

To measure progressive lens cannot use distortion check function

aspherical and spherical surface lens which be exceeded $\pm 10D$ may be will be falsely informed.

Aspherical lens may be erroneously assumed to progressive lens. Under this condition, please measure the lens in the condition of single vision lens.

c. Using method

To change “Distortion parameter” as “Distortion Found” or “Lens Found”

To put lens on measuring supporter; target district will demonstrate eight ● dots.

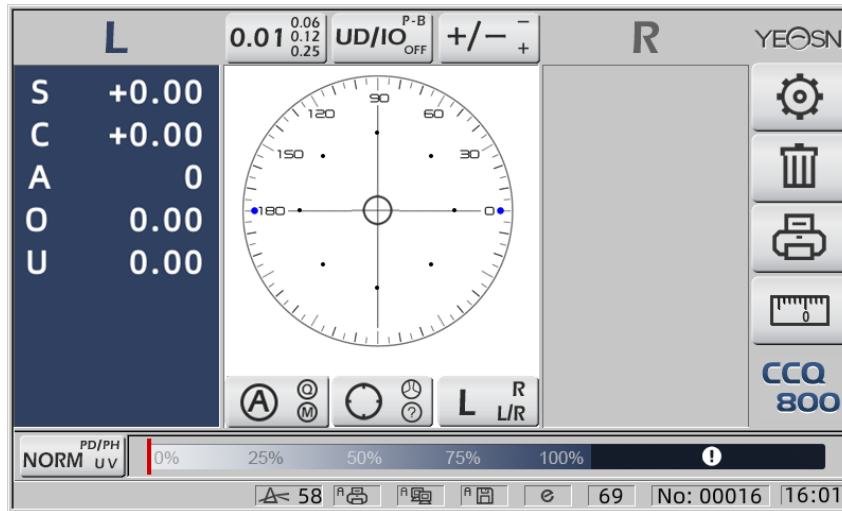

● dot demonstrate as seven kinds, depends on the difference of lens center power

When no distortion of lens found, all vertex power of eight dots are same, so eight ● will be same size.

When distortion of lens found, vertex power of eight dots are different from center vertex power.

Under this condition, ● will demonstrate as different size.

7 dot size as below:

.....●●●●●●● Conform to ISO 8980-1 standard 0~100%

The indicator of screen will show the distortion condition.

6.13 Printout

6.13.1 Set "Printer" at "ON" mode, and "OFF" at "User Info." mode, example in R/L state and L only state.

No.:			
<SINGLE>			
RIGHT		LEFT	
- 0.00	SPH	+ 0.00	
+ 0.00	CYL	+ 0.00	
0°	AXS	0°	
0 0.00	PSM	0 0.00	
U 0.00		U 0.00	
YEASN		CCQ-800	

No.:			
<SINGLE>			
		LEFT	
	SPH	+ 0.00	
	CYL	+ 0.00	
	AXS	0°	
	PSM	0 0.00	
		U 0.00	
YEASN		CCQ-800	

6.13.2 Set "Printer" at "ON" mode, and "OFF" at "User Info." mode, example in Contact Lens measurement state and PD measurement state.

No.: <CONTACT>			No.: <SINGLE>		
RIGHT		LEFT	RIGHT		LEFT
- 0.00	SE	+ 0.00	+ 0.00	SPH	+ 0.00
+ 0.00	SPH	+ 0.00	+ 0.00	CYL	+ 0.00
+ 0.00	CYL	+ 0.00	0°	AXS	0°
0 0.00	AXS	0°	0 0.00	PSM	0 0.00
0 0.00	PSM	0 0.00	U 0.00		U 0.00
U 0.00		U 0.00	----- PD -----		
			0.0	20.0	20.0
YEASN	CCQ-800		YEASN	CCQ-800	

6.13.3 Set "Economic print" or "Auto print" at "Printer" and "OFF" at "User info.", example of Contact Lens measurement result and PD measurement result in economic print mode.

No.: <CONTACT>			No.: <SINGLE>		
RIGHT		LEFT	RIGHT		LEFT
- 0.00	SE	+ 0.00	+ 0.00	SPH	+ 0.00
+ 0.00	SPH	+ 0.00	+ 0.00	CYL	+ 0.00
+ 0.00	CYL	+ 0.00	0°	AXS	0°
0 0.00	AXS	0°	0 0.00	PSM	0 0.00
0 0.00	PSM	0 0.00	U 0.00		U 0.00
U 0.00		U 0.00	----- PD -----		
			0.0	20.0	20.0
YEASN	CCQ-800		YEASN	CCQ-800	

6.13.4 Set "ON" at "Printer" and "User info.". Example in R/L state and L only state.

No.: NAME:YEASN CHONGQING.CHINA <SINGLE>			No.: NAME:YEASN CHONGQING.CHINA <SINGLE>		
RIGHT		LEFT		LEFT	
- 0.00	SPH	+ 0.00		SPH	+ 0.00
+ 0.00	CYL	+ 0.00		CYL	+ 0.00
0°	AXS	0°		AXS	0°
0 0.00	PSM	0 0.00		PSM	0 0.00
U 0.00		U 0.00			U 0.00
YEASN	CCQ-800		YEASN	CCQ-800	

6.14 After use

6.14.1 Switch off the instrument

Switch off the instrument under Measurement interface.

- If it's Parameter Setting interface, the parameter settings won't be saved after the instrument is switched off.

6.14.2 Dust-proof

When the device is not in use, turn it off and put the dust cover over the instrument. Dust may affect measurement accuracy.

- If dust on the instrument attracts moisture, it may cause short circuit or fire.

6.15 Parameter Setting

The auto focimeter has the function to change each parameter of the instrument according to customers' needs and preference.

6.15.1 Measurement interface shortcut setting

There are all kinds of shortcut parameter setting for commonly-used parameters on Measurement interface.

Below are detailed descriptions:

Choose step indication, every press would make the step change in the following order:





There are altogether 7 commonly-used shortcut settings working in the same way, they are step setting, prism indication setting, reading mode setting, right or left lens setting and additional function mode setting.

They are correspondent to "Step", "Prism indication", "Cylinder indication", "Reading", "Measurement modes", "R/ L lens" and "Function Modes" in "Lens", "Display" and "System" pages in parameter table.

6.15.2 Parameter table setting

Every parameter setting method is described below:

- a. Choose the needed value in parameter item.
- b. Save change, press , it returns to measurement interface, and the change is saved.
- c. Stop change, press , it returns to measurement mode, and the change is not saved.

6.16 Parameter table

6.16.1 "Lens" page of Parameter table

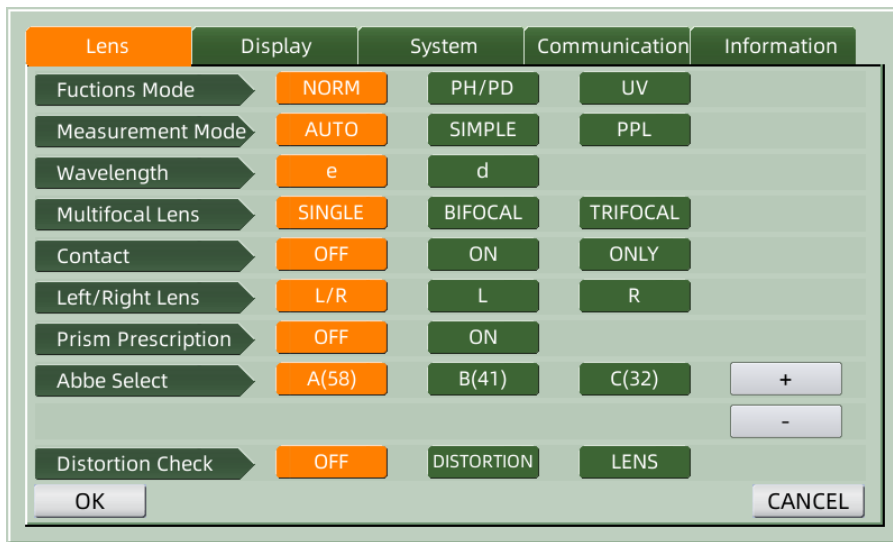

a. Functions Mode

Used to choose measurement function modes

b. Measurement Mode

AUTO	Single vision lens, bifocal lens, and progressive lens can be automatically identified and measured under such mode
SIMPLE	Normal Lens Measurement Mode
PPL	Progressive Power Lens Measurement Mode

c. Wavelength

It's used to choose e light (wavelength: 546.07nm) or d light (wavelength: 587.56nm) mode.

d. Multifocal Lens

When doing lens measurement, set the lens types into "single vision lens", "bifocal lens" or "trifocal lens".

- Bifocal lens should be measured under progressive lens measurement mode; trifocal lens should be measured under normal lens measurement mode.

e. Contact

OFF	Close contact lens measurement function
ON	Contact lens measurement, and PD quick measurement, reading modes, function modes, and measurement modes are disable
ONLY	Contact lens measurement mode is automatically recognized when starting the instrument

f. Left / Right Lens

L/R	It automatically identify the first lens as right lens, and switch automatically to left lens after the first data is fixed, and displays according to Nose pad position
L	It specifies left lens, and corresponding value will only be displayed on left side of the measurement screen
R	It specifies right lens, and corresponding value will only be displayed on right side of the measurement screen

g. Prism Prescription

To choose if start using prism prescription function

h. Abbe Select

ABBE was used for compensating measurement value error when measuring high-power lens.

Can choose ABBE from A, B, C.

According to lens materials, can input ABBE from A, B, C, scope 20-60

Default as A: 58, B: 41, C: 32.

i. Distortion Check

To choose if starting using distortion detection mode

OFF	Turn off distortion detection
Distortion found	When distortion found, will show dot symbol; if measurement condition stabilized, and no distortion found, dot symbol will disappear.
Lens found	To set up as "Lens", when put on lens, The dot mark will always be displayed

6.16.2 "Display" page of Parameter table

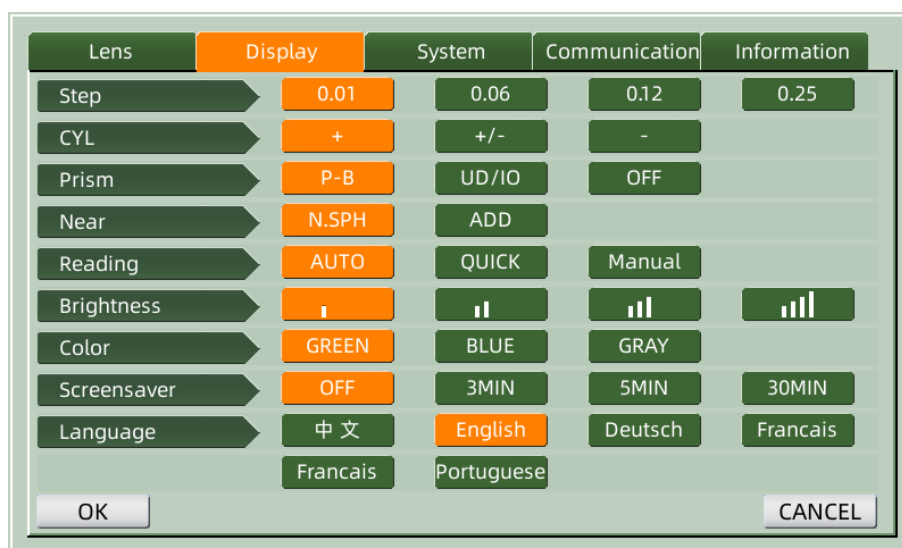

a. Step

Choose different increment of displayed data. Increment of axis and prism are always 1.

b. CYL

+	Cylinder display in + mode
+/-	Automatically identify cylinder, display in + or -
-	Cylinder display in - mode

c. PRISM

P-B	Prism value in the form of polar coordinate representation (Prism Δ , Base $^{\circ}$)
UD/IO	Prism value in the form of rectangular coordinate representation. In, out, up and down
OFF	Turn Off prism display

d. Near

Near power	N: 1st near power(distance power+1st Add power) 2: 2nd near power(distance power+2nd Add power)
Add power	Add: 1st added power Ad2: 2nd added power

e. Reading

AUTO	The measured data is fixed without pressing Read Key when target becomes blue in the process of alignment.
QUICK	When prism power lower than 0.5cm/m, will automatically lock.
Manual	The measured data is fixed by pressing Read Key when target becomes blue in the process of alignment.

f. Brightness

Brightness can be set to four grades from weak to strong.

g. Color

Color setting can be set in 3 modes.

h. Screen Saver

Set up the time before screen saver.

i. Language

Language can be set in 6 languages.

6.16.3 "System" page of Parameter table

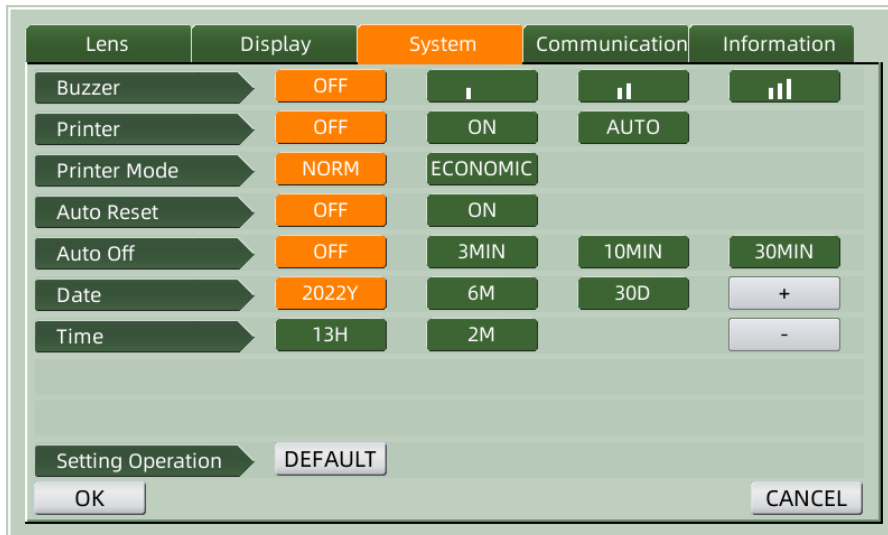

a. Buzzer

There are four settings of buzzer: OFF, Low, Medium and High.

b. Printer

Set whether start the printer. The hint messages will show in the status bar.

	Press "Print", and fixed data is not printed out
	Press "Print", and fixed data is printed out
	Print measured data automatically after measurement finish, and then the data is cleared.

c. Printer Mode

NORM	Press "Print", and fixed data is printed out in the form of standard space
ECONOMIC	Press "Print", and fixed data is printed out in the form of narrowed space

- The print result of "auto print is the same with "economic print".

d. Auto Reset

OFF	After pressing" Print", the measurement value result continue existing
ON	After pressing" Print", automatically clear the measurement value.

e. Auto Off

Set up the time before auto off.

f. Date YYYYMMDD Time HHMM

There are 5 parameter items for setting time and date. Choose one of them and do the setting with "+" or "-" command icon. Each press of "+" or "-" will make the one-way increment by 1.

g. Setting Operation

Parameter for setting is a command icon. Press it, and a dialogue box will pop up, showing "OK" or "Cancel" the change. To "OK" is to restart the instrument and all parameters restore to factory setting.(except time and date)

6.16.4 "Communication" parameter setting table

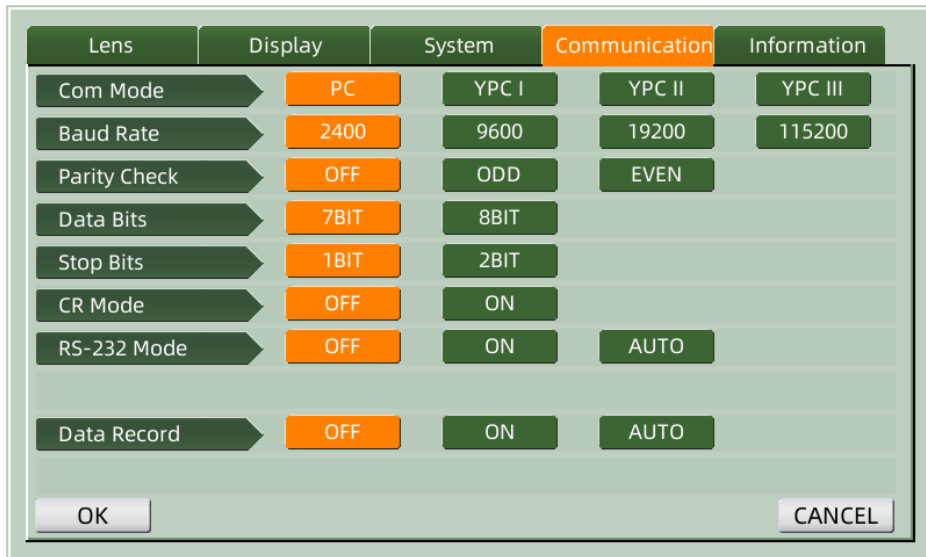

a. Com Mode

Choose outer communication equipment.

PC	Communication with PC
YCP I	Communication with Yeasn brand equipment corresponded with YCP I
YCP II	Communication with Yeasn brand equipment corresponded with YCP II
YCP III	Communication with Yeasn brand equipment corresponded with YCP III

b. Baud Rate

Choose communication transmission rate matched with outer equipment.

c. Parity Check

Set the operation of odd and even check.

d. Data Bits

Choose the digit of single character bit used in communication.

e. Stop Bits



Choose the digit of stop bits in communication.

f. CR Mode

Choose whether to add the additional CR (Carriage Return Character) in the end of the ready transmits data.



g. RS-232 Mode

Set whether to start RS-232 mode to transmit data. It will show the messages in the status bar.

	Don't use RS-232 mode
	Press "Print", and fixed data is put out through RS-232 connector
	Measured data will be automatically transmitted through RS-232 connector, and then the data is cleared.

h. Data Record

Set whether to keep the measured data record in the system. It will show the messages in the status bar.

	Don't Record the data.
	Press "Print", and record the measured data
	Finished measured data will be automatically recorded, and then the data is cleared.

- Before data transmission by USB, first turn on CCQ-800 auto focimeter, then connect one end of data cable to communication port, and connect another end to CCQ-800 auto focimeter; after the data transmission complete, pull out the cable end connected with CCQ-800. If the procedures above didn't been carried out strictly, it may cause the communication default of focimeter.

6.16.5 "Information" parameter setting table

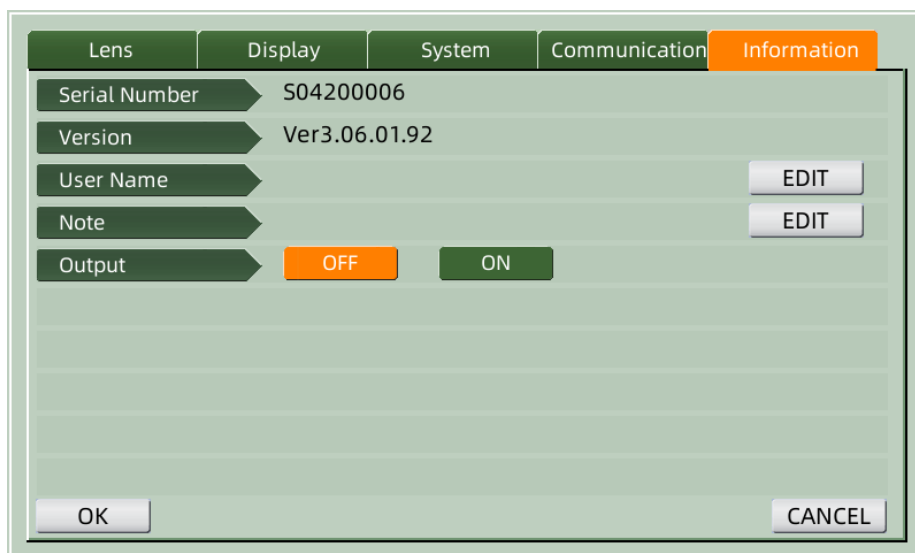

a. User Name and Note edit

Press "EDIT" tab behind "User Name" or "Note" accordingly, then the keyboard frame will popup.

Keyboard frame is composed of character (upper/lower letter, Arabic number and punctuation) and function key. Click the character or function key on keyboard frame, corresponding operation will display on edit bar.

- After user information edit is completed, press  to confirm, the user information can be saved.

b. Output

When starting, user info and note will be printed out.

7. Trouble-shooting

7.1 Troubleshooting method

If the instrument does not work properly, please find out the symptom and action according the table below:

Symptom	Action
Pilot lamp is off	Check the power connector, and reconnect if there is disconnection
Data is not printed out	Check the printer paper. If the paper has been used up, set new printer paper The "Printer" parameter may be set to OFF, reset the parameter
The printer does work, but printed result cannot be obtained	The printer paper may be set with the wrong side up. Set it with the correct side up. If the paper gets stuck, the paper may not be set correctly. Set it again correctly.

- If the above actions are not working, please contact us for after-sales service.

7.2 Error messages and countermeasures

- If a message appears on the screen, find out the symptom and action according to the table below:

OD Init Error	Check the Lens support, press the restart button and restart the instrument
Please remove lens from Lens support	After removing the lens, press the restart button and restart the instrument
Dust detection. Please clean lens	Check Lens support. Remove the dust and dirt from the protective glass. Press the restart button to restart the instrument
Do you want to use Contact Lens support	Replace with spectacle Lens support, press the restart button to restart the instrument; or choose "NO" to quit measuring contact lens
Meas. Error	Check the Lens support. Remove the one which interrupts the measuring beam

- To guarantee the normal and safe operation of the equipment, a preventive check and maintenance should be conducted for the ME equipment and its parts every 6-12 months

(including performance check and safety check).

8. Cleaning and protection

8.1 Cleaning the protective glass

Remove the dust and dirt from protective glass regularly.

- a. Remove the Lens support.
- b. Blow off the dust and dirt on the surface of the protective glass with a blower.
- c. If it's still dirty, wipe gently with a lens cleaning paper moistened with alcohol.
 - Dust on the protective glass may affect the measurement precision. Take special care not to scratch the protective glass. Flaws on the glass substantially lower the reliability of measurement.

8.2 Cleaning the lens

- a. Blow off the dust and dirt on the surface of the lens with a blower.
- b. Wipe gently with a lens cleaning paper moistened with alcohol.
 - wipe the lens from the center to the outside clockwise.
- c. Check if the window is clean. If not, clean it again with a new paper.
 - Change the view angle to check the dirt clearly.

8.3 Others

Clean with soft cloth when the cover or dial becomes dirty. If there is dirt, wipe with cloth moistened with neutral detergent, and then dry it with dry soft cloth.

Clean frequency: Need check if optical path system is dusty when turn on instrument.

- The instrument no touch with patients, needn't disinfect.
- Do not use organic solvents like diluted paint, which will ruin the surface of the instrument.
- Wipe gently the screen or touch screen will be broken and lead to malfunction.
- Do not wipe with watered sponge or cloth, as water may go into the instrument and lead to malfunction.

9. Maintenance

9.1 Replacing printer paper

When a red line appears on the side of the printer paper, stop using the printer and replace with a new one. Detailed steps are shown below:

- a. Pull the transparent printing compartment door and open the printer cover.**
- b. Put the new printing paper roll into the printing box.**
 - **If the paper is turned upside down, the print data will not be displayed on the paper.**
- c. Pull out the printing paper along the paper outlet of the printer cover.**
- d. Close the printer cover and the transparent printing compartment door will reset automatically to complete the replacement.**
 - Do not run the printer while the printer paper is not set, or pull the paper in the printer forcefully, it may reduce the printer's life.

9.2 Refilling ink (applicable to Auto Focimeter with ink pad)

When marking becomes faint, it means you need to refill ink.

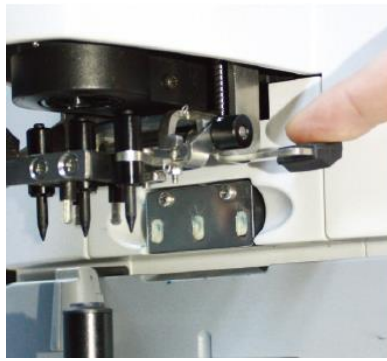

Fig.9.2.1 a



Fig.9.2.1 b

9.2.1 Remove the ink pad

- a. Hold the mark holder with right hand.
- b. Pull it out plumb with left thumb and index finger pressing the two ends of ink pad.

9.2.2 Remove the woolen felt

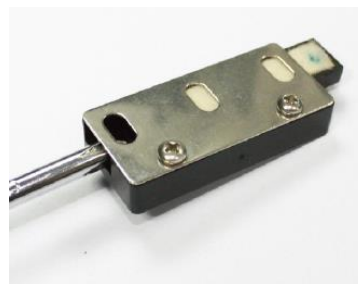

Fig.9.2.2 a

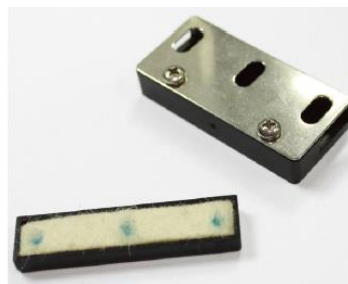

Fig.9.2.2 b

- a. Push the felt box out with tool.
- b. Slightly push out the felt pad.

9.2.3 Refill the ink

9.2.4 Put the refilled ink box back to the instrument with the two screws heading upward.

- Personnel not trained by YEASN do not repair the instrument.
- YEASN is not responsible for any accidents resulted from improper servicing.
- When performing maintenance work, secure a sufficient maintenance space, as Maintenance work in an insufficient space may result in injury.
- Manufacturer will provide circuit diagrams, component part lists, descriptions, calibration instructions to assist to Service Personnel in parts repair.

10. Environmental Conditions and Service Life

10.1 Environmental conditions for normal operation

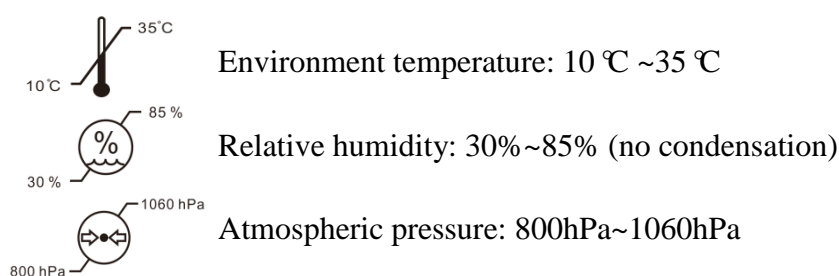

Indoor conditions: clean and without direct high light.

10.2 Environmental conditions for transportation and storage

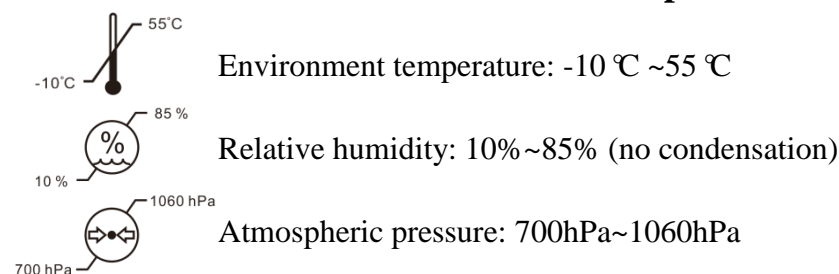

Indoor conditions: good ventilation and without corrosive gas.

10.3 Service life

The service life of the device is 8 years from first-time use with proper maintenance and care.

11. Environmental protection



INFORMATION FOR USERS

Please recycle or properly dispose of the used batteries and other wastes to protect the environment.

This product bears the selective sorting symbol for waste electrical and electronic equipment

(WEEE). This means that this product must be handled to the local collecting points or given back to retailer when you buy a new product, in a ratio of one to one pursuant to European Directive 2012/19/EU in order to be recycled or dismantled to minimize its impact on the environment.

Very small WEEE (no external dimension more than 25 cm) can be delivered to retailers free of charge to end-users and with no obligation to buy EEE of an equivalent type. For further information, please contact your local or regional authorities. Electronic products not included in the selective sorting process are potentially dangerous for the environment and human health due to the presence of hazardous substances. The unlawful disposal of the product carries a fine according to the legislation currently in force.

12. Manufacturer's Responsibility

The company is responsible for the safety, reliability and performance impact under below circumstances:

- Assembly, addition, modifications, alterations and repairs are carried out by authorized personnel by the company;
- Electrical facilities in the room are in conformity with relevant requirements, and
- The device is used according to the User Manual.

13. Electrical Schematic Diagram

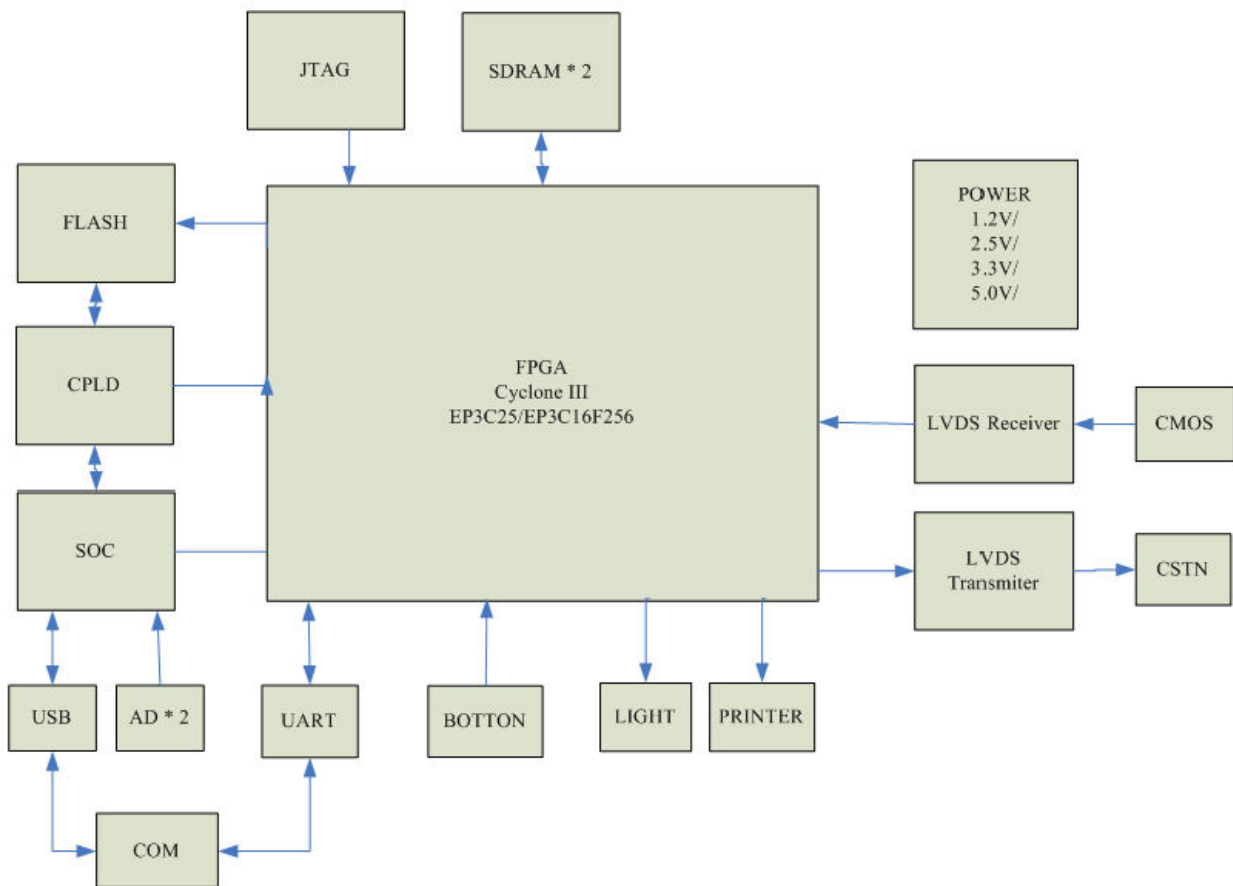

For further information and services, or any questions, please contact with the authorized dealer or manufacturer. We will be happy to help you.

14. Guidance of EMC and other interference

Guidance and Manufacturer’s declaration – Electromagnetic Emissions		
This CCQ-800 is intended for use in the electromagnetic environment specified below. The customer or the user of the CCQ-800 should assure that the device is used in such an environment.		
Emissions test	Compliance	Electromagnetic environment - guidance
RF emissions CISPR 11	Group 1	The CCQ-800 uses RF energy only for its internal function. Therefore, its RF emissions are very low and not likely to cause interference in nearby electronic equipment.
RF emissions CISPR 11	Class A	
Harmonic emissions IEC 61000-3-2	N/A	
Voltage fluctuations/ flicker emissions IEC 61000-3-3	N/A	

Guidance and manufacture's declaration – electromagnetic immunity

The CCQ-800 is intended for use in the electromagnetic environment specified below. The customer or the user of CCQ-800 should assure that it is used in such an environment.

Immunity test	IEC 60601 test level	Compliance level	Electromagnetic environment - guidance
Electrostatic discharge (ESD) IEC 61000-4-2	±8 kV contact ±15 kV air	±8 kV contact ±15 kV air	Floors should be wood, concrete or ceramic tile. If floor are covered with synthetic material, the relative humidity should be at least 30%.
Electrical fast transient/burst IEC 61000-4-4	±2 kV for power supply lines ±1 kV for input/output lines	±2kV for power supply lines	Mains power quality should be that of a typical commercial or hospital environment.
Surge IEC 61000-4-5	± 1 kV line(s) to line(s) ± 2 kV line(s) to earth	±1 kV differential mode ±2 kV common mode	Mains power quality should be that of a typical commercial or hospital environment.
Voltage dips, short interruptions and voltage variations on power supply input lines IEC 61000-4-11	<5% U_T (>95% dip in U_T) for 0.5 cycle 40% U_T (60% dip in U_T) for 5 cycles 70% U_T (30% dip in U_T) for 25 cycles <5% U_T (>95% dip in U_T) for 5 sec	<5% U_T (>95% dip in U_T) for 0.5 cycle 40% U_T (60% dip in U_T) for 5 cycles 70% U_T (30% dip in U_T) for 25 cycles <5% U_T (>95% dip in U_T) for 5 sec	Mains power quality should be that of a typical commercial or hospital environment. If the user of the YF-100 requires continued operation during power mains interruptions, it is recommended that the YF-100 be powered from an uninterruptible power supply or a battery.
Power frequency (50Hz/60Hz) magnetic field IEC 61000-4-8	3 A/m	3 A/m	Power frequency magnetic fields should be at levels characteristic of a typical location in a typical commercial or hospital environment.

NOTE U_T is the a.c. mains voltage prior to application of the test level.

Guidance and Manufacturer's Declaration – Electromagnetic Immunity

This CCQ-800 is intended for use in the electromagnetic environment specified below. The customer or the user of the CCQ-800 should assure that the device is used in such an environment.

Immunity test	IEC60601 Test level	Compliance level	Electromagnetic environment - guidance
Conducted RF IEC 61000-4-6	3 Vrms 150 kHz to 80 MHz	3 V	Portable and mobile RF communications equipment should be used no closer to any part of the CCQ-800, including cables, than the recommended separation distance calculated from the equation applicable to the frequency of the transmitter. Recommended separation distance $d = \left[\frac{3,5}{V_1} \right] \sqrt{P}$ $d = \left[\frac{3,5}{E_1} \right] \sqrt{P} \quad 80 \text{ MHz to } 800 \text{ MHz}$ $d = \left[\frac{7}{E_1} \right] \sqrt{P} \quad 800 \text{ MHz to } 2,5 \text{ GHz}$ Where P is the maximum output power rating of the transmitter in watts (W) according to the transmitter manufacturer and d is the recommended separation distance in metres (m). Field strengths from fixed RF transmitters, as determined by an electromagnetic site survey, ^a should be less than the compliance level in each frequency range. ^b Interference may occur in the vicinity of equipment marked with the following symbol: 
Radiated RF IEC 61000-4-3	3 V/m 80 MHz to 2.5 GHz	3 V/m	

Recommended separation distances between portable and mobile RF communications equipment and the CCQ-800.

The CCQ-800 is intended for use in an electromagnetic environment in which radiated RF disturbances are controlled. The customer or the user of the CCQ-800 can help prevent electromagnetic interference by maintaining a minimum distance between portable and mobile RF communications equipment (transmitters) and the CCQ-800 as recommended below, according to the maximum output power of the communications equipment.

Rated maximum output power of transmitter(W)	Separation distance according to frequency of transmitter(m)		
	150 KHz to 80 MHz	80 MHz to 800 MHz	800 MHz to 2.5 GHz
	$d = [\frac{3,5}{V_1}] \sqrt{P}$	$d = [\frac{3,5}{E_1}] \sqrt{P}$	$d = [\frac{7}{E_1}] \sqrt{P}$
0.01	0.117	0.117	0.233
0.1	0.36999	0.36999	0.73681
1	1.17	1.17	2.33
10	3.69986	3.69986	7.36811
100	11.7	11.7	23.3